

EG III HX

EG III HX EP Monster Truck



505005
Instruction Manual



Ready To Run



FOUR WHEEL DRIVE



WATER PROOF



ELECTRIC



2.4G RADIO



BRUSHLESS



Thank you for choosing the Team Magic E6 III HX. The E6 III HX is designed to be fun to drive and use top quality parts for performance and durability. Before you start building your new R/C kit, we suggest you read through the instruction manual first. Be sure to check all assembly and performance tips before you start. We hope you enjoy the building processes.

General Building Tips:

- ▶ Read the instruction manual before building.
- ▶ Clear a work area and try to work on a light color towel to avoid missing dropped parts.
- ▶ Don't over-tighten fasteners. Many assembly problems are caused by over-tightening screws or nuts. Don't use too large a grip. Please go slowly and feel the resistance build. Just snug it up.
- ▶ When it doesn't fit, please double check. If an assembly is not going together correctly, then either there really is a bad fit (e.g. a part is damaged or defective) or a mistake in assembly. Always re-read the instructions when there are any problems. If you cannot figure out what's wrong, always ask dealer, distributor or Team Magic. Don't use force beyond what the instructions call for.
- ▶ Using the right tools makes assembly much easier. The instructions below finely indicate you what tools to get to make things easier. We don't want to scare you by saying that all these tools are required, but you will have a easier time if you have them. Borrow them from a friend to check if necessary.
- ▶ The assembly is arranged so that you will open the bag and finish that bag before you go on to the next bag. Sometimes, you will have parts remaining at the end of a bag. These will become part of the following bags.

A Good Dealer Is Extremely Important!!

A good hobby dealer can help you with most assembly problems you might encounter. This is the main reason why you should buy your kits from a good dealer rather than from the cheapest dealer. Bring your problematic parts to the dealer and, most likely, you'll walk away soon thereafter with the problem solved. If you think that you really don't have the mechanical skills to complete the assembly, you may pay your dealer to finish the job for you.



Thank you for purchasing the E6 III HX. To drive the car, you will need to check the following procedures.



- ▶ After vehicle gets wetly, please unplug the connecting wire from ESC and battery to avoid put users in danger. Also making rustproof process for rings and metal parts is highly recommended.



- ▶ If the vehicle has high opportunity to drive on the water as necessary, please seal the air aperture on back of tires by types before users perform this action to prevent the sponge to absorb the water from inside of tires.

1 Included tools

- Cross Wrench (17mm)

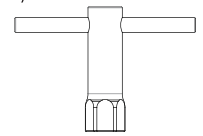

- L Type Hex Wrench (2.5mm) #117031

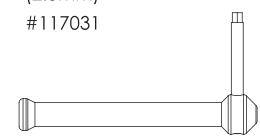

2 Required items

- AA Alkaline Or Rechargeable Batteries For Transmitter, 4pcs

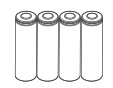

- 7.4v Rechargeable Battery Pack X 2

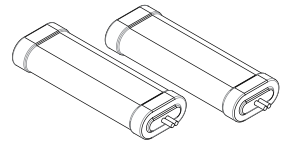

- Battery Pack charger

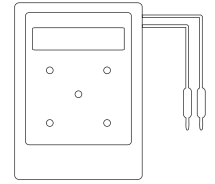

3 Helpful equipments

- Hobby Knife (Warning!! This knife cuts nylon parts and fingers with equal ease. Be careful.)



- Body Scissors (for body cutting) #116006

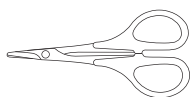

- Needlenose Pliers

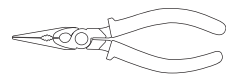

- TM Black RC Hex Wrench Metric Size 1.5mm #117057-1

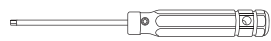

- TM Black RC Hex Wrench Metric Size 2.0mm #117057-2

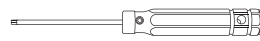

- TM Black RC Hex Wrench Metric Size 2.5mm #117057-3

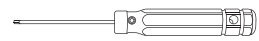

- TM Black RC Hex Wrench Metric Size 3.0mm #117057-4

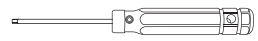

- TM Black HC Nut Driver 5.5mm (for 3mm nut) #117010

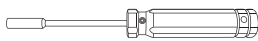

(Please always buy these items in model shops)

Instruction & Setup Manual

1 Transmitter Function

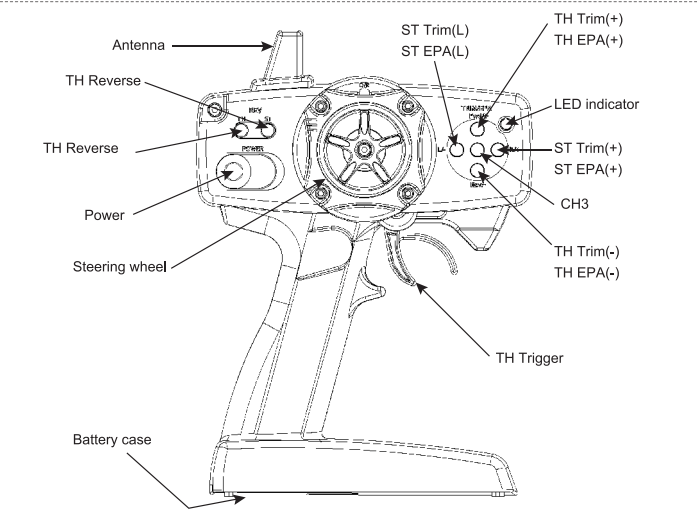

2 Operating Procedure

01 Install 4pcs AA batteries to the H.A.R.D transmitter.

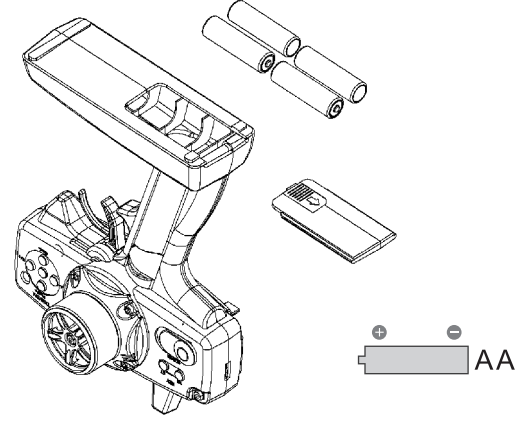

02

- Turn the steering wheel right to turn the front tires go right.
- Turn the steering wheel left to turn the front tires go left.



03

- Press the throttle trigger to moving forward the vehicle
- Push forward the throttle trigger to brake and reverse the vehicle.



3 Binding (connecting the receiver to transmitter)

Binding the Receiver to the Transmitter

"Binding" is tuning the receiver to the frequencies used by the transmitter. Bind the receiver to the transmitter as follows:

1. With both transmitter and receiver turned off, place the units no more than 30 cm (1 ft) apart.
2. While holding down the receiver's BIND button, apply power to the receiver. Its LED will start to flash steadily, indicating that the unit is in binding mode, a state that lasts up to 30 seconds.
3. Turn the transmitter on. It will immediately go into binding mode, a state that lasts one second.
4. When the receiver's LED shines steadily, binding is complete.

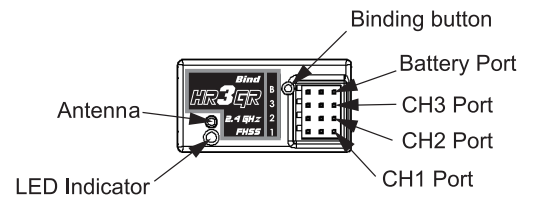

【DECLARATION】

Thanks for purchasing our Electronic Speed Controller (ESC). The power system for RC model can be very dangerous, so please read this manual carefully. In that we have no control over the correct use, installation, application, or maintenance of our products, no liability shall be assumed nor accepted for any damages, losses or costs resulting from the use of the product. Any claims arising from the operating, failure of malfunctioning etc. will be denied. We assume no liability for personal injury, consequential damages resulting from our product or our workmanship.

【FEATURES】

- ★ Completely water-proof and dust-proof. The ESC works properly even under water. (Please remove the cooling fan when running car in water, and after running, please make the ESC clean and then dry it to avoid the oxidation of copper connectors)
- ★ Excellent start-up, acceleration and linearity features, suitable for truggy (especially short course trucks) and buggy.
- ★ The built-in switching mode BEC has powerful output to supply all electronic equipments.
- ★ There is a mounting stand for installing the ESC on chassis easily and firmly.
- ★ Proportional ABS brake function with 5 steps of maximum brake force adjustment, 8 steps of drag-brake force adjustment. Also compatible with the mechanical disc-brake system.
- ★ Multiple protection features: Low voltage cut-off protection / Over-heat protection / Throttle signal loss protection / Motor blocked protection
- ★ Easily programmed with the SET button of the ESC, and also compatible with pocket-sized Program Card.
- ★ External Programming Port (EPP), easy to connect with program card, and also works as power port for cooling fan.

【SPECIFICATIONS】

Model	WP-SC10-RTR	WP-SC8-RTR	WP-SC8-ADV-RTR	WP-S8A-RTR	WP-S8B-RTR
Cont./Burst Current	80A / 520A	80A/520A	120A/760A	100A/650A	150A/950A
Motor Supported	Sensorless brushless motors				
Cars Applicable	1/10 SCT/Truggy/Buggy/Monster	1/10 SCT/Truggy/Buggy/Monster 1/8 SCT/Buggy Incl. Traxxas 1/10 Truggy/Buggy	1/8 SCT/Buggy/Truggy Incl. Traxxas 1/10 Truggy/Buggy	1/8 Truggy/Monster	1/8 Truggy/Monster
Motor Limit	2S Lipo: KV≤6000 3S Lipo: KV≤4000	2S Lipo: KV≤6000 3S Lipo: KV≤4000 4S Lipo: KV≤2600	4S Lipo: KV≤3000 6S Lipo: KV≤2400		
Resistance	0.0007 ohm	0.0004 ohm	0.0005 ohm	0.00035 ohm	
Battery	6-9 cells NiMH 2-3S Lipo	6-12 cells NiMH 2-4S Lipo	6-18 cells NiMH 2-6S Lipo		
BEC Output <i>Note 1</i>	6V/3A Linear mode / 6V/3A Switch mode				
Dimension	59.3(L) × 38.4(W) × 33.6(H)			59.5(L) × 48(W) × 42(H)	
Weight (With Wires)	110g	113g	173g	178g	

NOTE1 : The cooling fans of ESC is supplied by the built-in BEC, so it is always working under 6V .

【BEGIN TO USE THE NEW ESC】

WARNING! For safety, please always keep the wheels away from the track when switching on the ESC.

1. Connect The ESC, Motor, Receiver, Battery And Servo

The #A, #B, #C wires of the ESC can be connected with the motor wires freely (without any sequence). If the motor runs in the opposite direction, please swap any two wire connections.

2. Throttle Range Setting (Throttle Range Calibration)

In order to make the ESC match the throttle range, you must calibrate it when you begin to use a new ESC, or a new transmitter, or change the settings of neutral position of the throttle stick, ATV or EPA

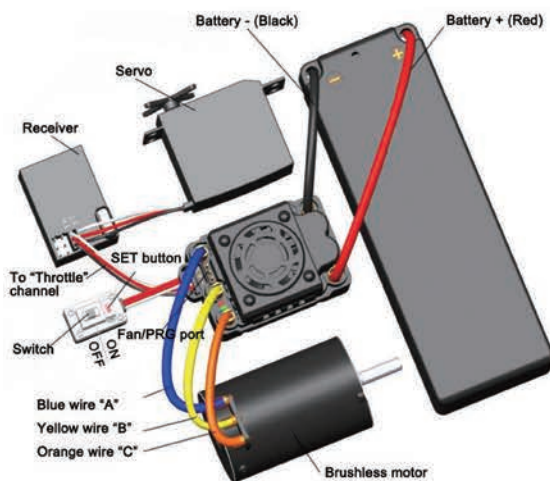

parameters, etc.

The following pictures show how to set the throttle range with a Futaba™ transmitter.

- Switch off the ESC, turn on the transmitter, set the direction of throttle channel to "REV", set the "EPA/ATV" value of throttle channel to "100%", and disable the ABS function of your transmitter.
- Hold the "SET" key and then switch on the ESC, and release the "SET" key as soon as possible when the red LED begins to flash. (*Note2*)

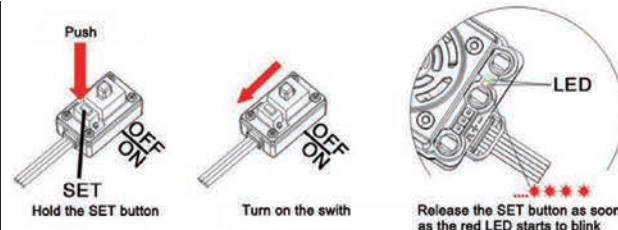

Note2: If you don't release the "SET" key as soon as the red LED begins to flash, the ESC will enter the program mode, in such a case, please switch off the ESC and re-calibrate the throttle range again from step A to step D.

- Set the 3 points according to the steps shown in the pictures on the right side.

1) The neutral point

Move the throttle stick at the neutral point, and then click the SET key, the green LED flashes 1 time.

2) The end point of forward direction

Move the throttle stick at the end point of forward direction, and then click the SET key, the green LED flashes 2 times.

3) The end point of backward direction

Move the throttle stick at the end point of backward direction, and then click the SET key, the green LED flashes 3 times.

- Throttle range is calibrated; motor can be started after 3 seconds.

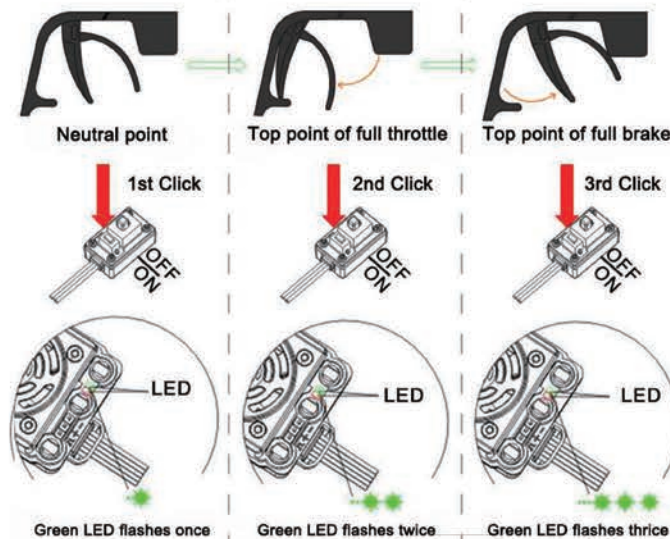

3. Check LED Status In Normal Running

- ▶ Normally, if the throttle stick is located in the neutral range, neither the red LED nor the green LED lights.
- ▶ The red LED lights when the car is running forward or backward and it will flash quickly when the car is braking.
- ▶ The green LED lights when the throttle stick is moved to the top point of the forward zone.

【PROGRAMMABLE ITEMS LIST】

(The *italics texts* in the following form are the default settings)

Programmable Items	Programmable Value								
	1	2	3	4	5	6	7	8	9
1. Running Mode	Forward with Brake	<i>Forward/Reverse with Brake</i>	Forward and Reverse						
2. Drag Brake Force	0%	5%	10%	20%	40%	60%	80%	100%	
3. Low Voltage Cut-Off Threshold	Non-Protection	2.6V/Cell	2.8V/Cell	<i>3.0V /Cell</i>	3.2V /Cell	3.4V /Cell			
4. Start Mode(Punch)	Level1	Level2	Level3	Level4	<i>Level5</i>	Level6	Level7	Level8	Level9
5. Max Brake Force	25%	<i>50%</i>	<i>75%</i>	100%	Disable				

1. Programmable Values



1.1. **Running Mode:** In "Forward with Brake" mode, the car can go forward and brake, but cannot go backward, this mode is suitable for competition; "Forward/Reverse with Brake" mode provides backward function, which is suitable for daily training.

Note: "Forward/Reverse with Brake" mode uses "Double-click" method to make the car go backward. When you move the throttle stick from forward zone to backward zone for the first time (The 1st "click"), the ESC begins to brake the motor, the motor speeds down but it is still running, not completely stopped, so the backward action is NOT happened immediately. When the throttle stick is moved to the backward zone again (The 2nd "click"), if the motor speed is slowed down to zero (i.e. stopped), the backward action will happen. The "Double-Click" method can prevent mistakenly reversing action when the brake function is frequently used in steering.

By the way, in the process of braking or reversing, if the throttle stick is moved to forward zone, the motor will run forward at once.

"Forward/Reverse" mode uses "Single-click" to make the car go backward. When you move the throttle stick from forward zone to backward zone, the car will go backward immediately. This mode is usually used for the Rock Crawler.

1.2. **Drag Brake Force:** Set the amount of drag brake applied at neutral throttle to simulate the slight braking effect of a neutral brushed motor while coasting.

1.3. **Low Voltage Cut-Off:** The function prevents the lithium battery pack from over discharging. The ESC detects the battery's voltage at any time, if the voltage is lower than the threshold for 2 seconds, the output power will be cut off, and the red LED flashes in such a way: "☆-☆-, ☆-☆-, ☆-☆-".

1.4. **Start Mode (Also called "Punch"):** Select from "Level1" to "Level9" as you like. Level1 has a very soft start effect, while level9 has a very aggressive start effect. From Level1 to Level9, the start force is increasing. Please note that if you choose "Level7" to "Level9" mode, you must use good quality battery with powerful discharge ability, otherwise these modes cannot get the burst start effect as you want. If the motor cannot run smoothly (that means the motor is trembling), it may be caused by the weak discharge ability of the battery, please choose a better one or a softer gear ratio.

1.5. **Maximum Brake Force:** The ESC provides proportional brake function. The brake force is related to the position of the throttle stick. Maximum brake force refers to the force when the throttle stick is located at the end point of the backward zone. A very large brake force can shorten the brake time, but it may damage the gears. The "Disable" option inhibits the inherent brake function of the speed controller. When this option is selected, the brake function is realized by a traditional mechanical disc-brake system driven by a servo.

2. Reset All Items To Default Values

At any time when the throttle is located in neutral zone (except in the throttle calibration or parameters program process),

Trouble	Possible Reason	Solution
After power on, motor doesn't work, and the cooling fan doesn't work	The connections between battery pack and ESC are not correct	Check the power connections Replace the connectors
After power on, motor can't work, but emits "beep-beep-, beep-beep-" alert tone. (Every "beep-beep-" has a time interval of 1 second)	Input voltage is abnormal, too high or too low	Check the voltage of the battery pack
After power on, red LED always lights, the motor doesn't work	Throttle signal is abnormal	Plug the control wire into the throttle channel of the receiver correctly.
The motor runs in the opposite direction when it is accelerated	The wire connections between ESC and the motor are not correct	Swap any two wire connections between the ESC and the motor.
The motor suddenly stops running while in working state	The throttle signal is lost	Check the transmitter and the receiver Check the signal wire from the throttle channel of your receiver
	The ESC has entered the Low Voltage Protection Mode or Over-heat Protection Mode	Red LED flashing means Low Voltage. Green LED flashing means Over-heat
When accelerating quickly, the motor stops or trembles	1) The battery has a bad discharge performance 2) Gear ratio is too aggressive 3) The "Start Mode (Punch)" of the ESC is too aggressive	1) Use a better battery 2) Use lower KV motor or softer gear ratio 3) Set the "Start Mode (Punch)" to a softer value
When the throttle stick is in the neutral range, the red LED and the green LED flashes synchronously	Over current protection, motor demagnetization, or motor is over load	1) Reduce the load (Use softer gear ratio or reduce the input voltage) 2) Change the motor
Cannot connected with the LED Program Card or LCD Program Box	Mistakenly uses the Rx wire to connect to the program card/box.	Connect the program card/box to the special programming port of the ESC, don't use the Rx wire.

hold the "SET" key for over 3 seconds, the red LED and green LED will flash at the same time , which means each programmable item has be reset to its default value.

[TROUBLE SHOOTING]

[PROGRAM THE ESC]

1. Program the ESC with the SET button on the ESC

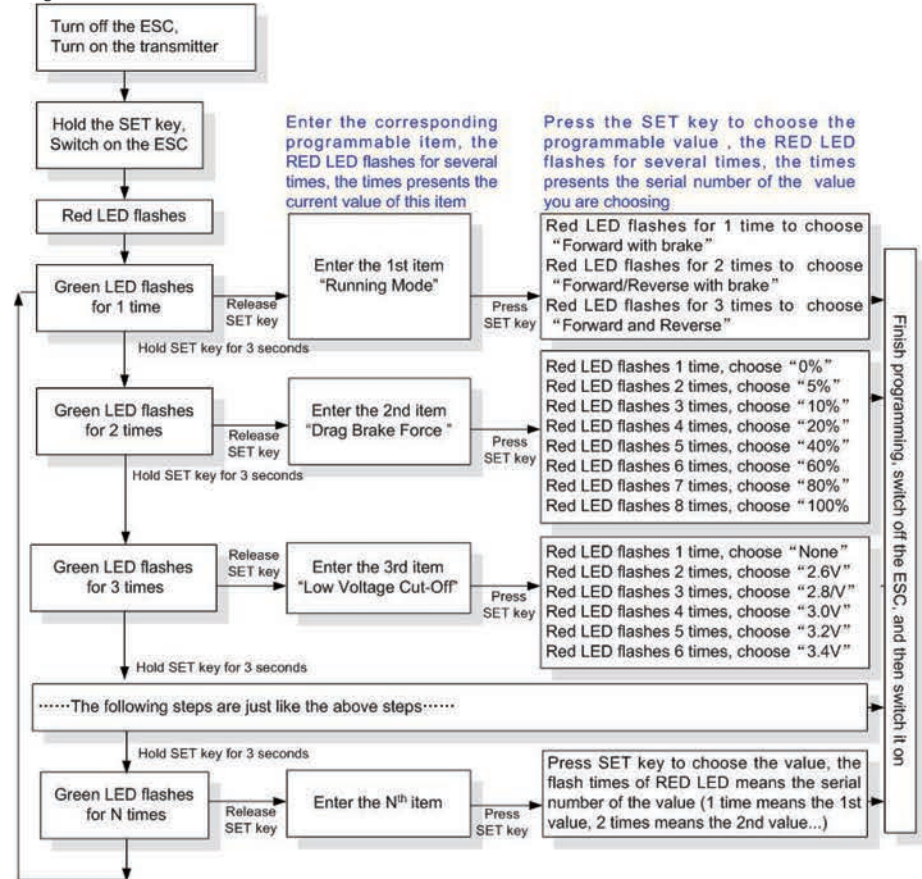

Note:

- In the program process, the motor will emit "Beep" tone when the LED is flashing.
- We use a long time flash and long "Beep---" tone to represent number "5" for easily identify the items of the big number.
 - "A long time flash" (Motor sounds "B---") = the No. 5 item
 - "A long time flash + a short time flash" (Motor sounds "B---B") = the No. 6 item
 - "A long time flash + 2 short times flash" (Motor sounds "B---BB") = the No. 7 item
 - "A long time flash + 3 short times flash" (Motor sounds "B---BBB") = the No. 8 item
 - "A long time flash + 4 short times flash" (Motor sounds "B---BBBB") = the No. 9 item

2. Program the ESC with the LED program box (Optional equipment)

Note3: The Rx wire of the ESC (for connecting receiver) CANNOT be used to connect with the LED Program Card. Please only use the special port between the terminals ABC to connect with the Program Card.





E6 III RTR HX

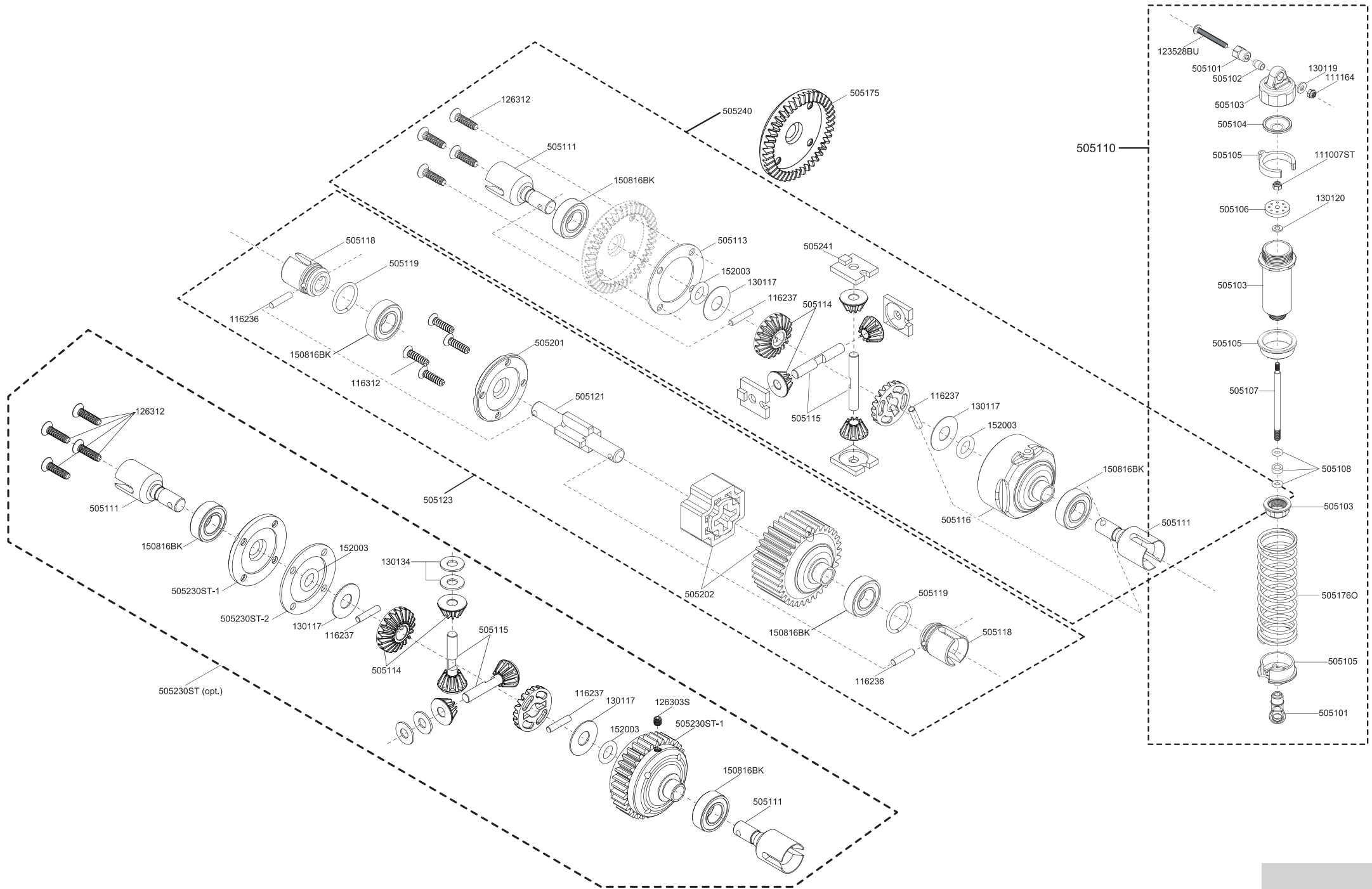

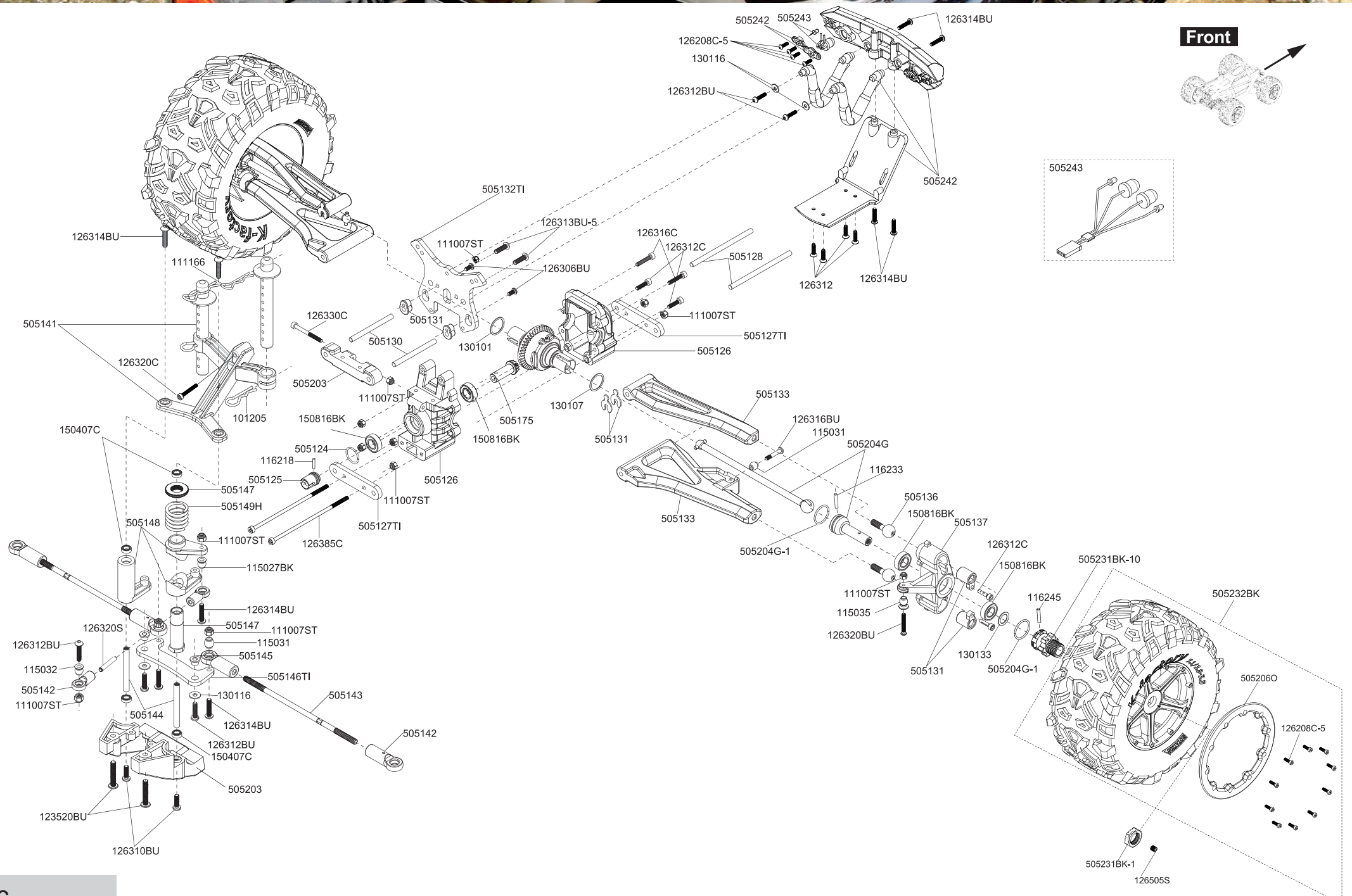



E6 III RTR HX

Front

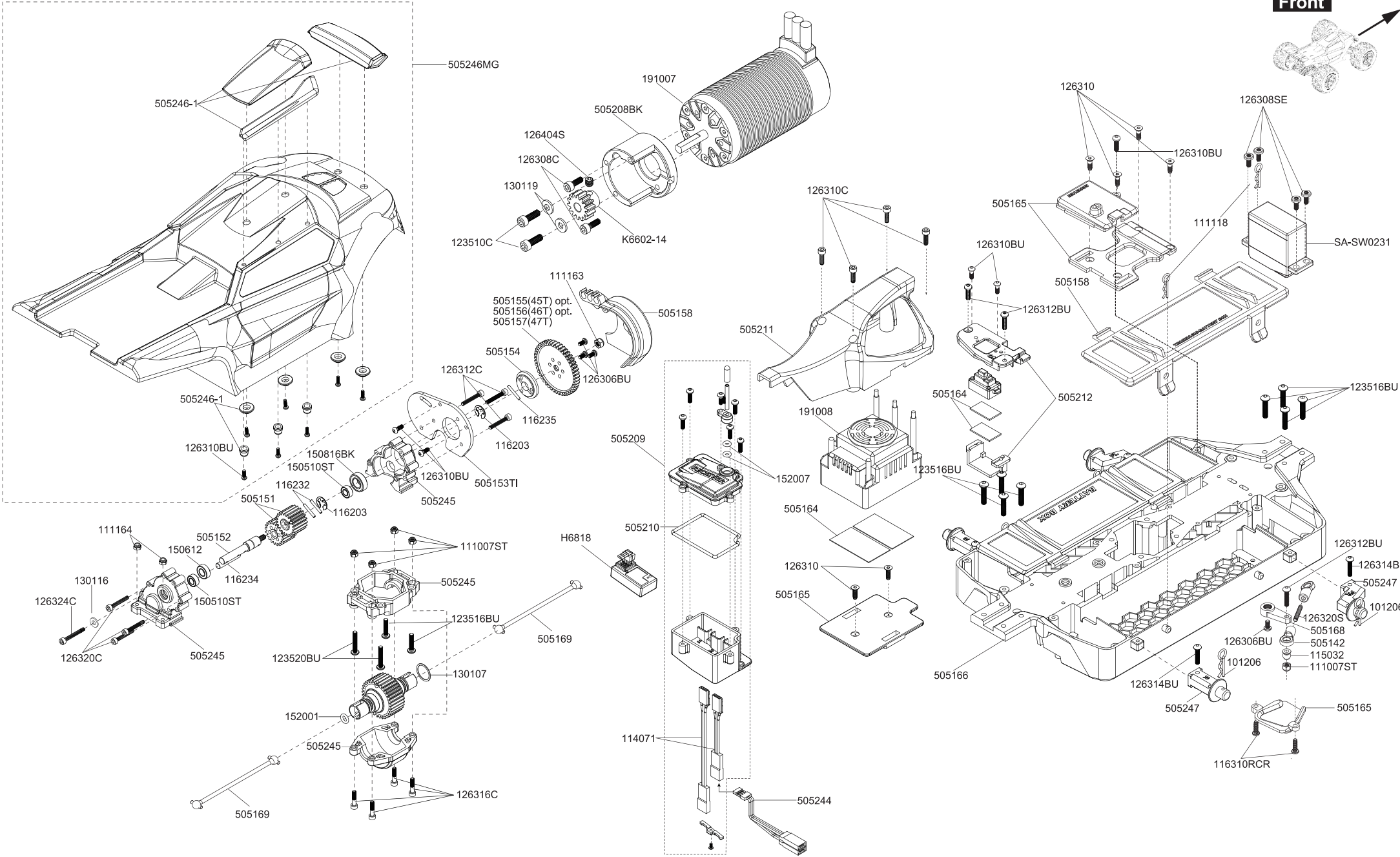
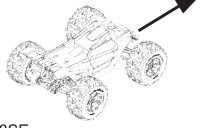

Front

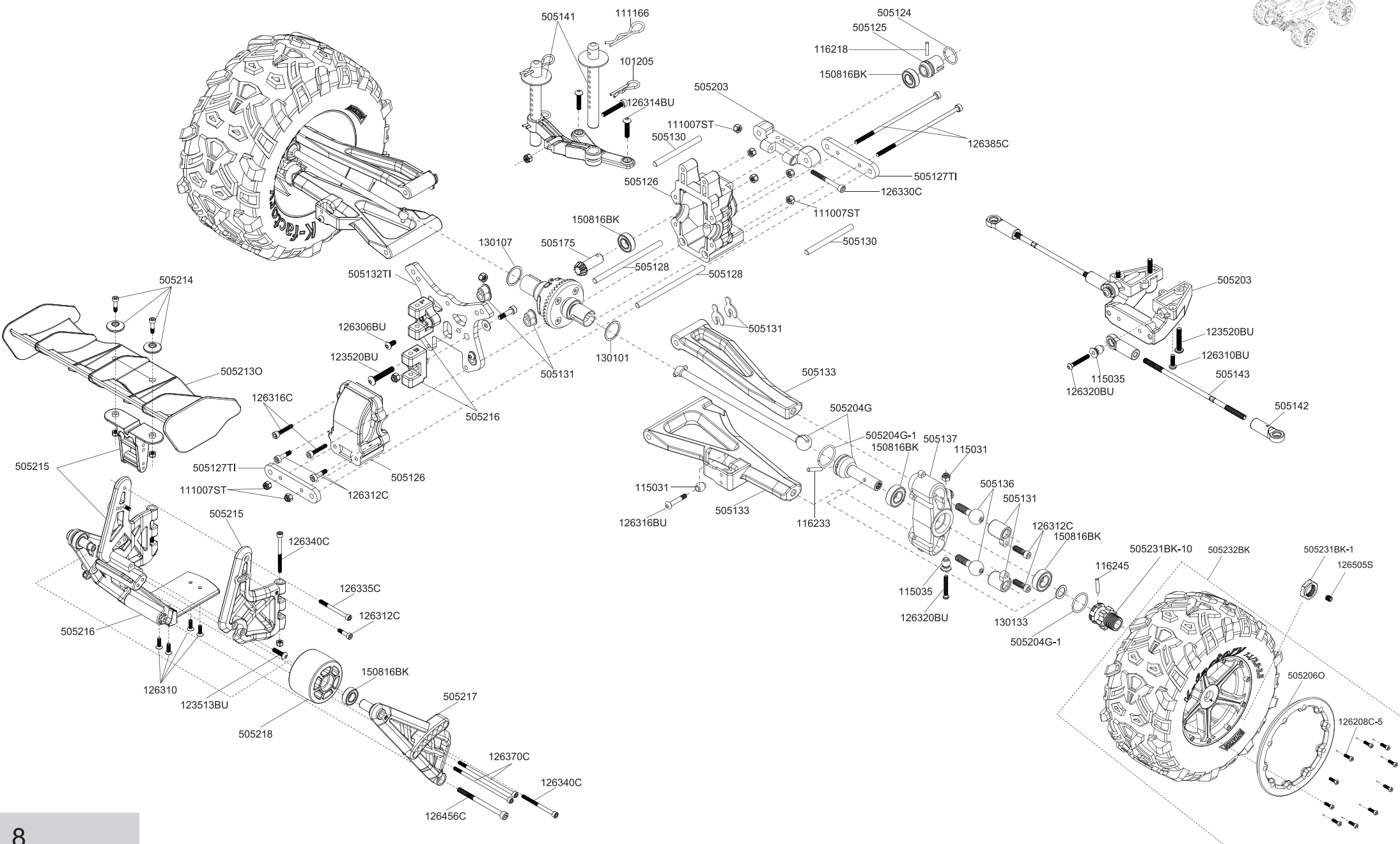
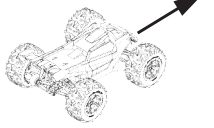



Team Magic Model Industrial co. Ltd.

No.185-2, 38th Road, Taichung industrial Park, Taichung, Taiwan 407

E-mail: service@teammagic.com.tw

Web: www.teammagic.com.tw

Tel: 886-4-23552606 Fax: 886-4-23552946

MADE IN TAIWAN
61511

